

# **KINGDAR**

## *Panel Systems*

*Scope*  
*Vast*  
*Ecore*

## *Deskling Systems*

*IVIK*

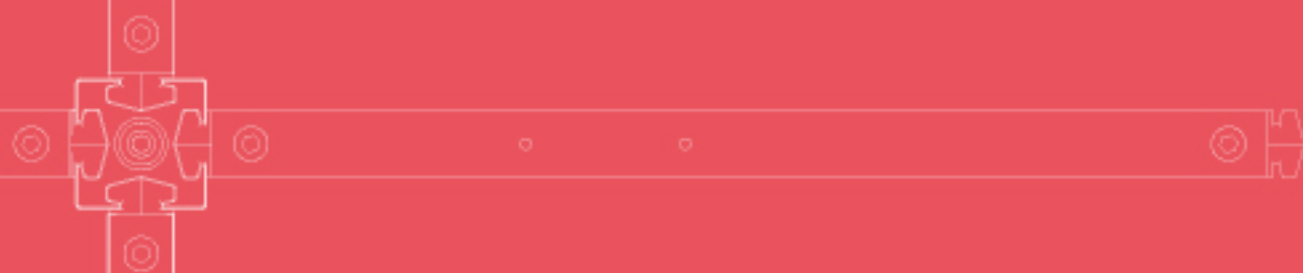

# Our Unique Partition Systems

Seeking to transform unsustainable consumption and production due to one earth we are sharing.

Our mission is treasuring the resource and being environmental friendly on every process since the concept phase. Not only elegant, stylish and durable but also recyclable and reusable by using modularized concept to install or knock down parts easily.



Scope



Vast



Ecore



IVIK





## Scope

Our systems are engineered around the concept of synergy. By having this focus our systems can combine and unify comfortably with each other, giving the user freedom to select components from each system that best suit their own individualised needs.

Scope is a versatile panel system that gives the office landscape a contemporary aesthetic. Its clever design allows it to integrate into the comprehensive Axis, Mint and Ecore systems in a revolutionary way.

We believe that the more flexibility we can offer through our systems the more enriched your office environment will become. With a greatly enriched systems furniture solution, a more positive work environment and added efficiency is sure to follow.

### SCOPE Series

The combination of Axis system's tall partitions and Ecore's light door panel gives a feeling of openness, whilst still offering total privacy to the user.

## Scope



Hanging storage units and accessories make the office space user-friendly and effective.



Scope can be installed up to a height of 2100mm. Door panels are also available, which add complete privacy to the user's personal space. Also, Scope features a complete cable raceway that conceals all power and data through conduits in the partitions.



Scope



Storage, desking and other office accessories connect through specially designed extrusions in Scope's panel system.

A wide range of finishes are available for the Scope system.

Scope



Scope is as effective in open plan office landscape as it is in more traditional segmented offices. This layer of flexibility coupled with Scope's ability to incorporate the Mint, Axis or Ecore systems makes it one of the most adaptable systems furniture solutions available.







An entire collection of screen-hung accessories is available. They can be easily taken off or moved along the screen. They are a great space-saving solution and an effective way of organising one's office.

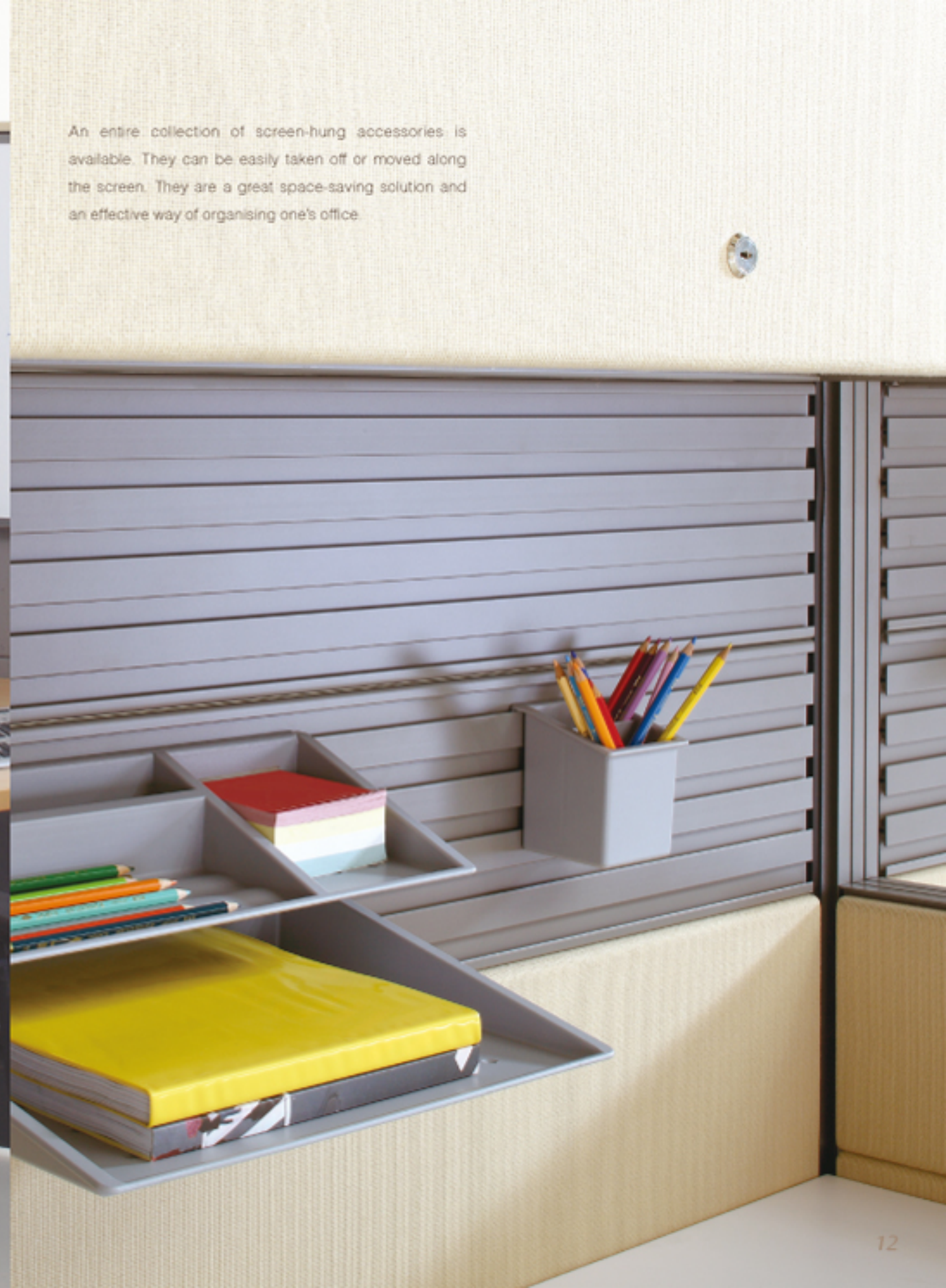





Screen top panels allow for a layer of privacy whilst still maintaining a work-friendly open sense of space.

Screen hung storage units tie in neatly to Scope's partitions and discreetly store away files and folders leaving the office uncluttered and easy to work in.



*Scope*

*Let Us  
Brighten up  
Your Business*



# Scope

## Family



AXIS

Product Name	AXISW
Partition Thickness	80 mm
Panel Thickness	16 mm
Edge Finishing	Wood Veneer
Product Features	Wood veneer finishing and wooden panels.



AXISW

Product Name	AXIS
Partition Thickness	80 mm
Panel Thickness	16 mm
Edge Finishing	Powder Coating
Product Features	Axis partition system is constructed with posts, frames and panels to form a square panel partition.



AXIS+Mint

Product Name	AXIS668
Partition Thickness	66 mm
Panel Thickness	9 mm
Edge Finishing	Powder Coating
Product Features	Partition thickness is readjusted to 66mm.



AXIS668

Product Name	AXIS+Mint
Partition Thickness	80 or 66 + 40 mm
Panel Thickness	16 or 9 + 9 mm
Edge Finishing	Powder Coating Ecore : Anodized
Product Features	Axis system integrated with the Mint system which allows the space to be flexible and feature a complete cable management system.

Product Name	AXIS660
Partition Thickness	66 mm
Panel Thickness	9 mm
Edge Finishing	Powder Coating Mint : Anodize
Product Features	Kick plate is not required. Can integrate with Axis 668.



AXIS660

Product Name	AXIS+Ecore
Partition Thickness	80 or 66 + 27 mm
Panel Thickness	16 or 9 + 27 mm
Edge Finishing	Powder Coating
Product Features	Axis system integrated with the Ecore system becomes a light and attractive alternative.



AXIS+Ecore

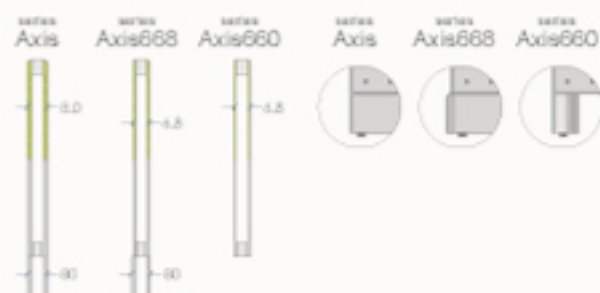



# Scope

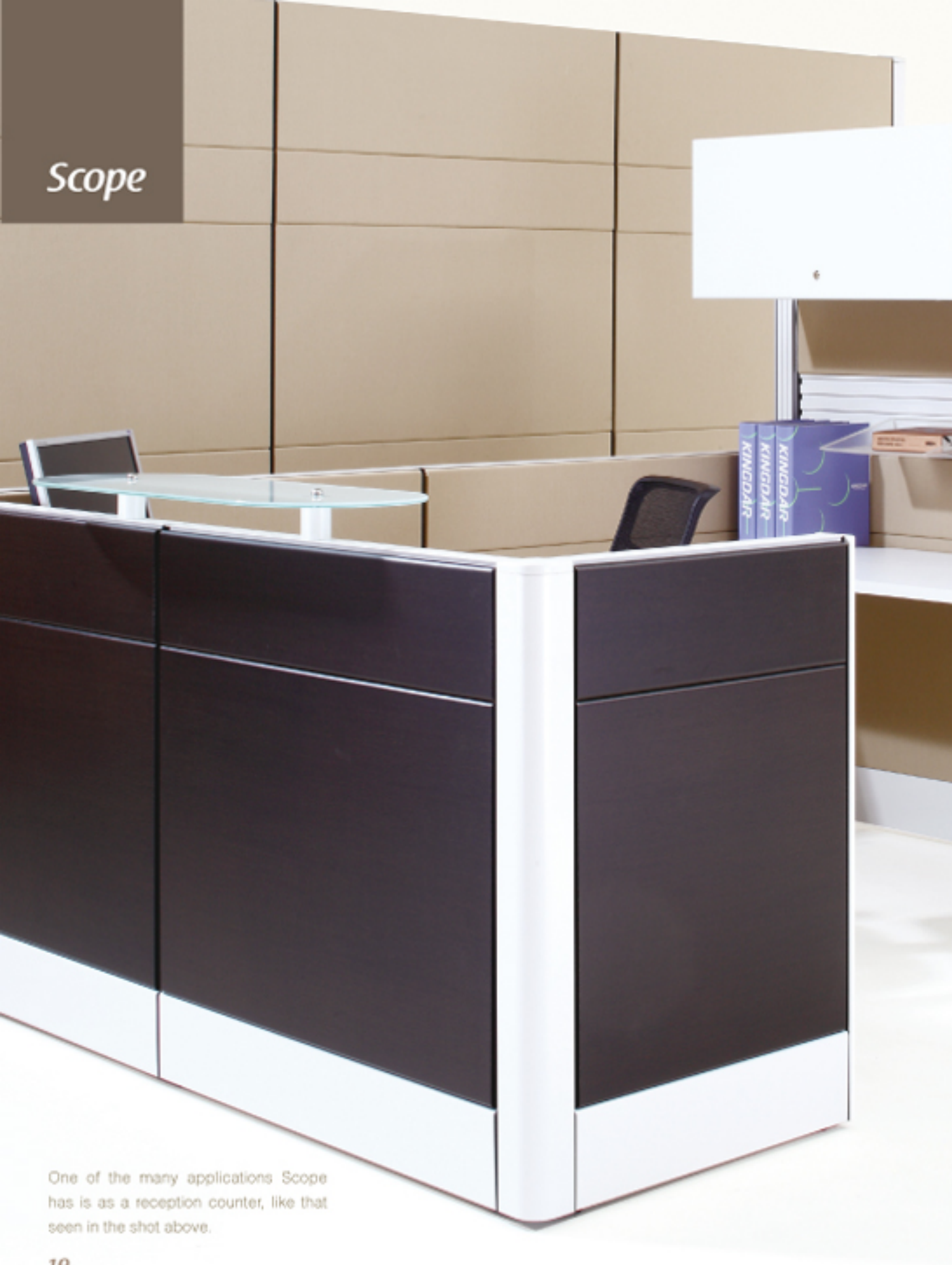

One of the many applications Scope has is as a reception counter, like that seen in the shot above.

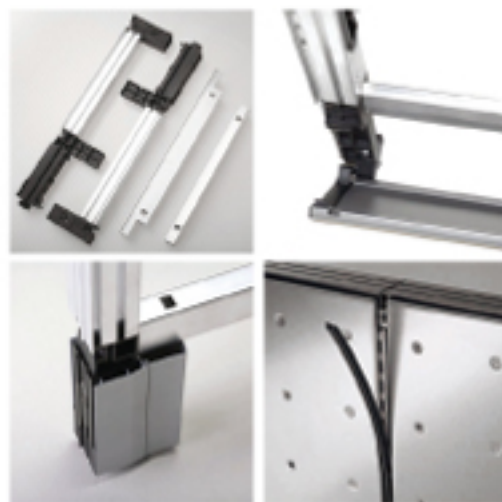
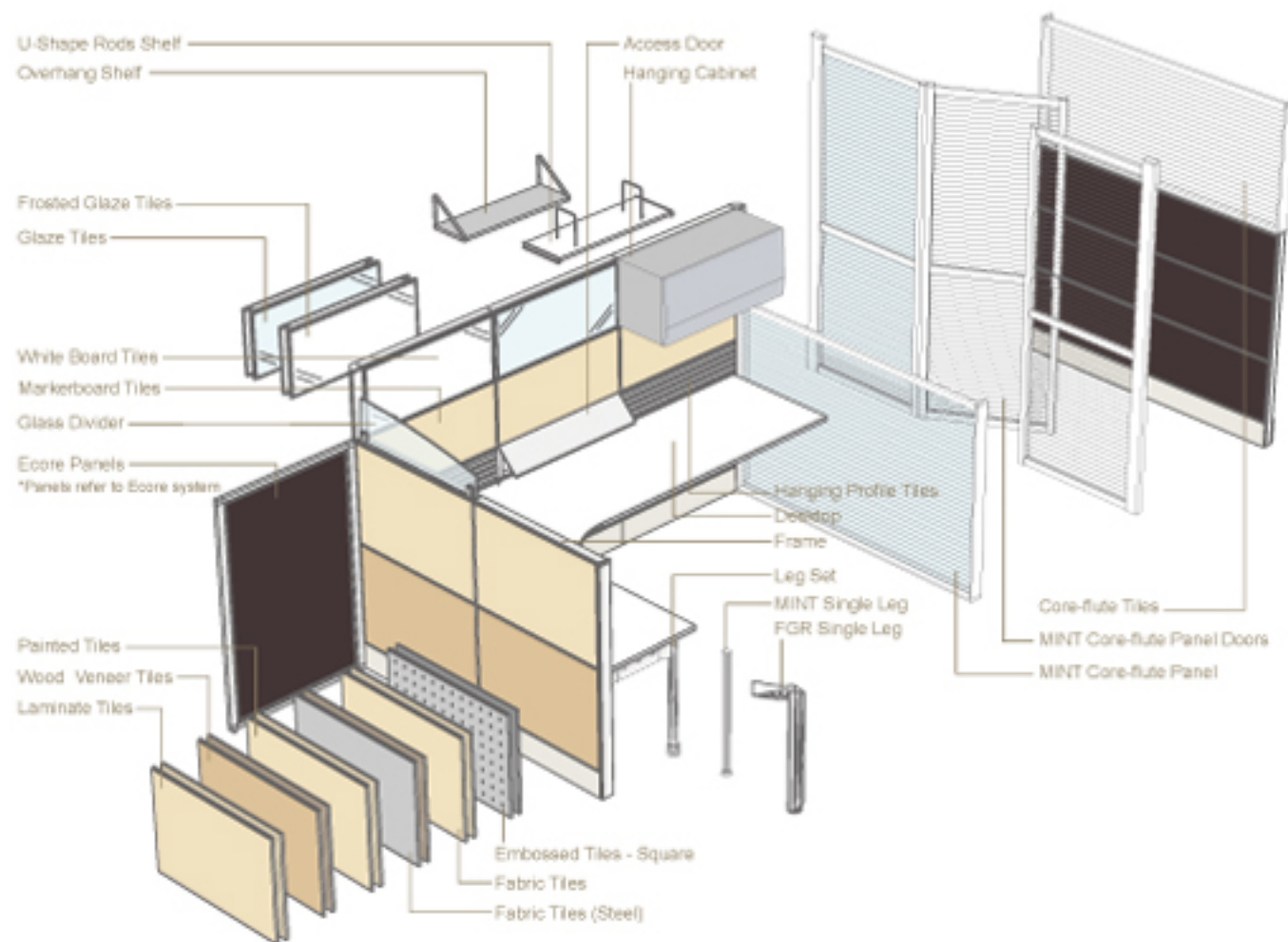

Scope's specially designed componentry is easy to install, modify and reinstall. Additionally, many different configurations can be made from a small set of components.



Scope



## SCOPE Series

Scope has the versatility to combine different height panels, up to 2100mm high, allowing for visually enriching tiered office landscapes to be created.

## SCOPE

Scope features a complete power and data management system that runs discreetly through the partition screens. The placement of power and data outlets is very flexible and outlets or cable routing can be changed with relative ease.

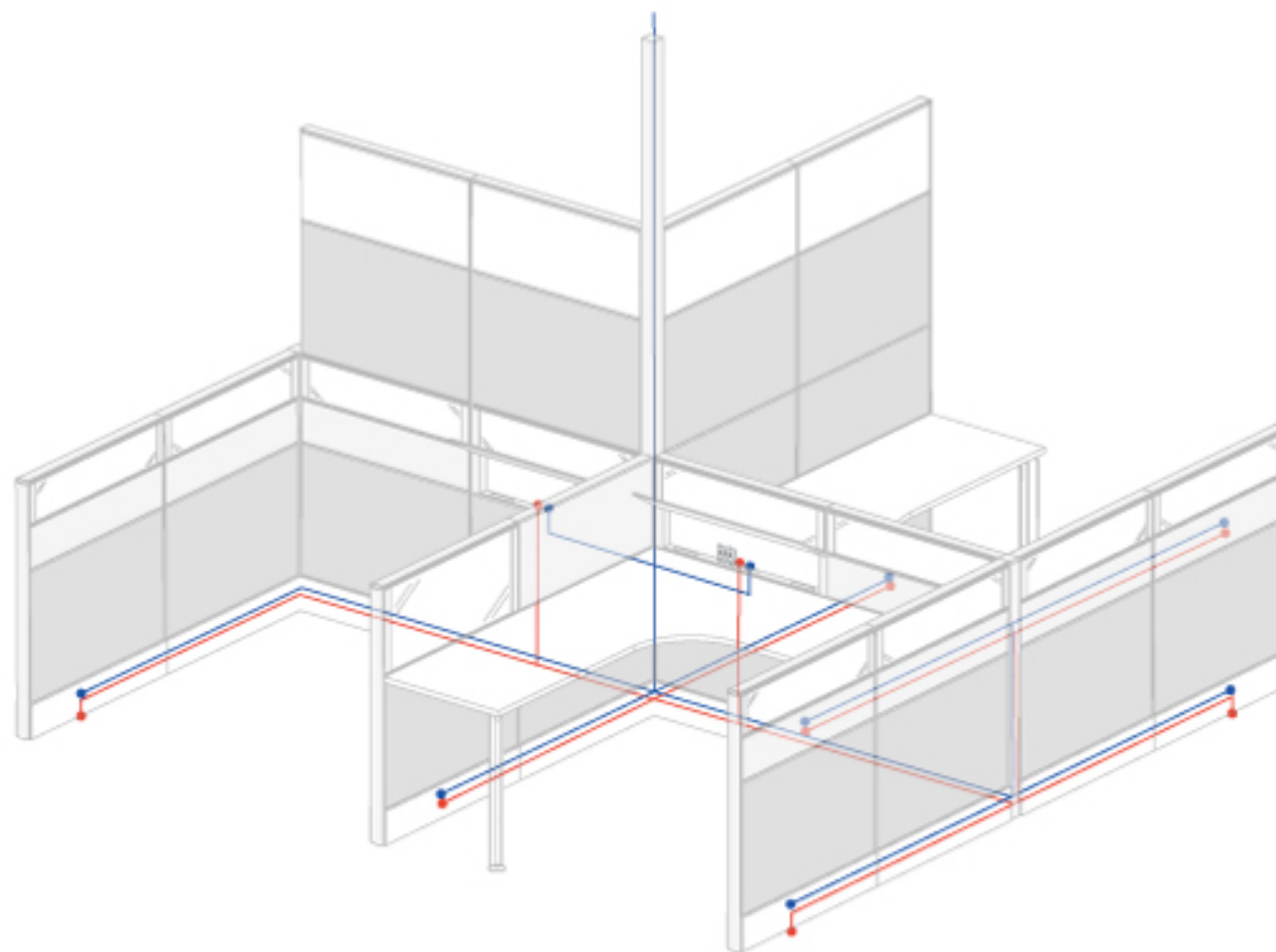

Scope can be made into a height of 2100mm managerial working area, arranged with door panels giving more privacy to personal space.

Combination between Perfect hanging system and other accessories makes the environment more efficient.



## Scope

### Portfolios



## Projects

With Scope's flexibility, it gets easily with any office interior. Additionally, its combinatorial capabilities allow a solution to be tailored exclusively to your needs.

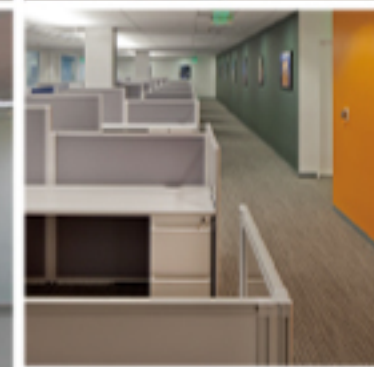
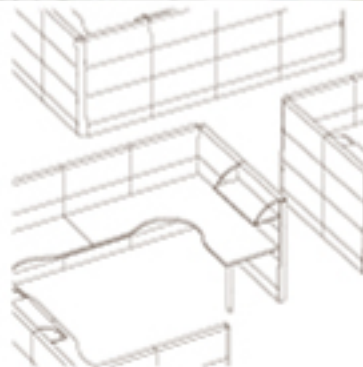



Vast



## *VAST Series*

The Vast system is distinguished by a powerful relationship between its panels and posts. It is a practicable system solution, developed to meet the needs of modern office planning. Its steady structure, compact panels, high level of customisability, range of accessories and ease of installation also make it a highly adaptive and elegant system.

Vast features an anodised aluminium panel system with 50mm thick posts and 20mm thick screens. It is available in a choice of fabric, melamine, glazed or embossed steel panels. Furthermore, power and data are easily accommodated through its unique raceway system.



*Vast*



## ***VAST Series***

The Vast system contains a sophisticated amount of engineering in its components, yet maintains a sleek and visually pleasing aesthetic not often found in systems that can do so much. Importantly, the slender look is backed by a system that is strong and sturdy.



Vast



Many combinations are possible with the Vast system, allowing the user to create modern work environments tailored most effectively to their own workplace. Vast completes its elegant look with stylised translucent plastic pole cap-tops





*Vast*

### *VAST Series*

Vast features a cable raceway that interacts with any of the fabric, melamine, glazed or embossed steel panels. Additionally, the raceway panels are detachable and allow easy access to power and data cables.



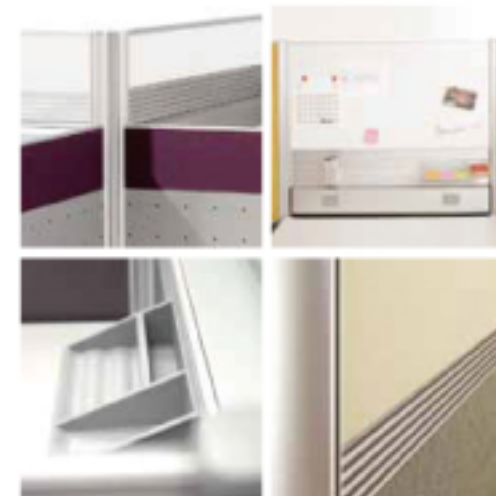
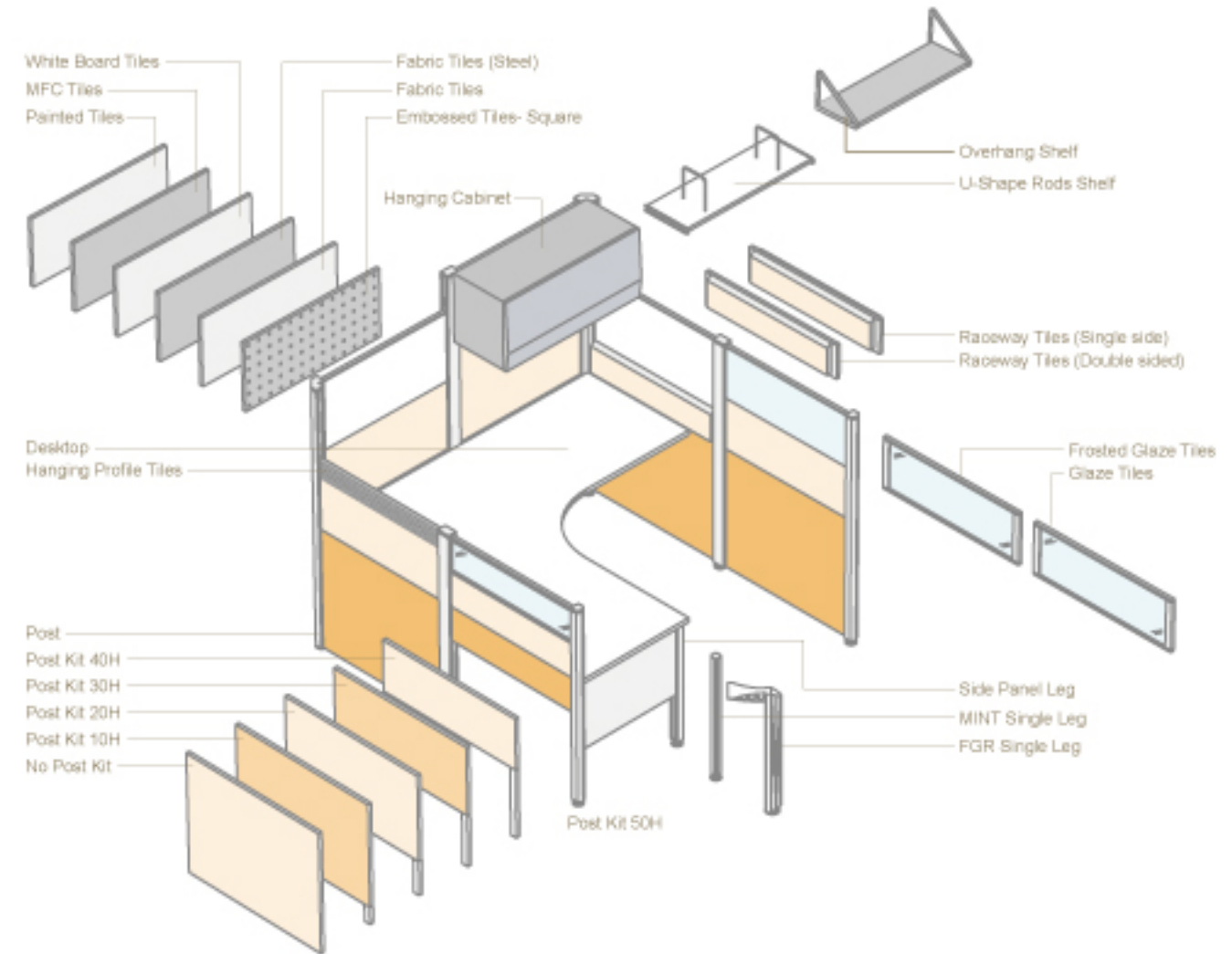

Vast systems configure easily by way of extrusions in the posts which link components together. Many configurations are possible, and with hanging storage units and accessories that attach directly onto Vast screens an entire office solution can be completed with Vast.



## VAST

The cable management raceway is intelligently engineered to provide the user with easy access to sufficient power and data outlets, whilst keeping the desktop and flooring free of electrical wires and cables.

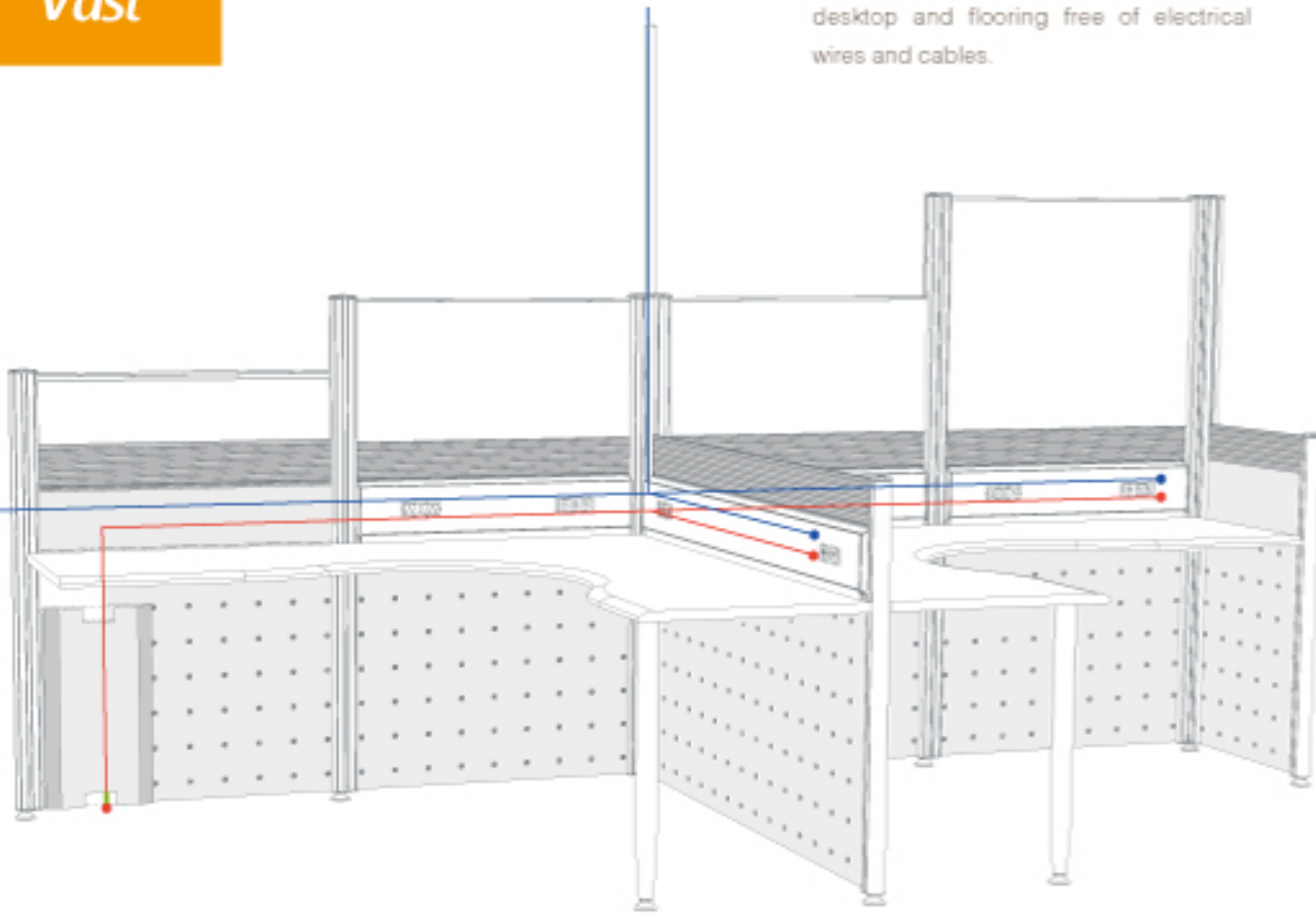

Many different finishes can be chosen for the Vast system, allowing it to be tailored to any specific interior environment and corporate culture.







Country  
Taipei

System  
Vast

Vast

Portfolios

### Projects

Vast has become a favourite of architects and interior designers because of its sleek aesthetics and practicality ensures a system's furniture solution that adds value to your company.



Vast

Portfolios

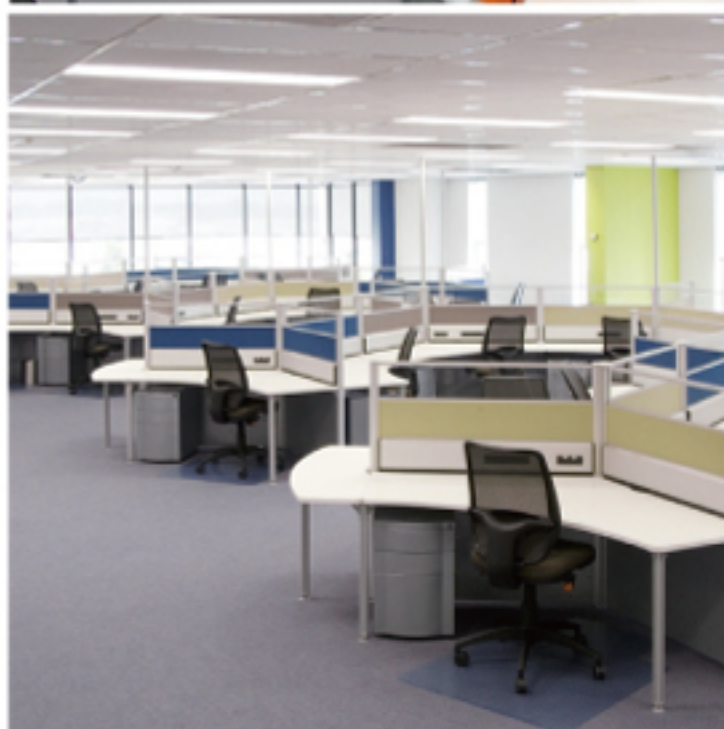
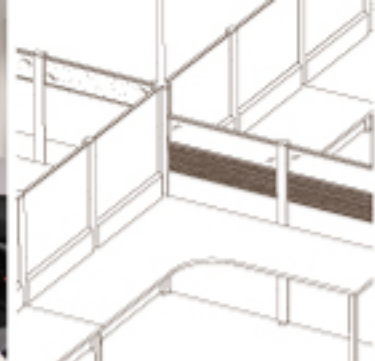

## Projects

With Vast's adaptability and pleasing aesthetics, it fits easily into any office interior and creates an effective contemporary office landscape.





*Ecore*



## *ECORE*

The Ecore series offers floor based and desk mounted screens. Its simple design adds a fresh aesthetic to office layouts. Its screens are slim, yet sturdy, and the frame features an inbuilt accessory bar on which you can hang a host of accessories from.





*Ecore*





*Ecore*



Ecore is a versatile system, able to combine a series of floor to desk high panels and desktop panels in a configuration of workstations, like that shown above.



*Ecore*



Ecore features practical and stylish screen hung shelves that are both strong and easily adjustable. When Ecore is paired with glass screen-top panels the range is given an elegant contemporary aesthetic, whilst still delivering exceptional value for money.





## *ECORE Series*

Ecore creates a division between workstations that is both practical and aesthetically pleasing.



Ecore offers an all-encompassing systems furniture solution that can be configured to allow for "built-in" storage units, like that shown above. Combined with the wide variety of finishes available it truly is a totally versatile system's furniture solution.



*Ecore*







Ecore offers outstanding flexibility with many unique and interesting configurations possible, like the zig-zag silhouette shown above.

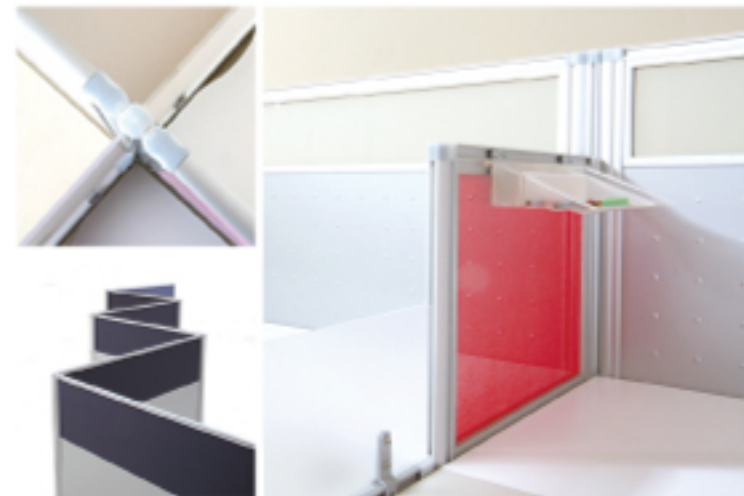
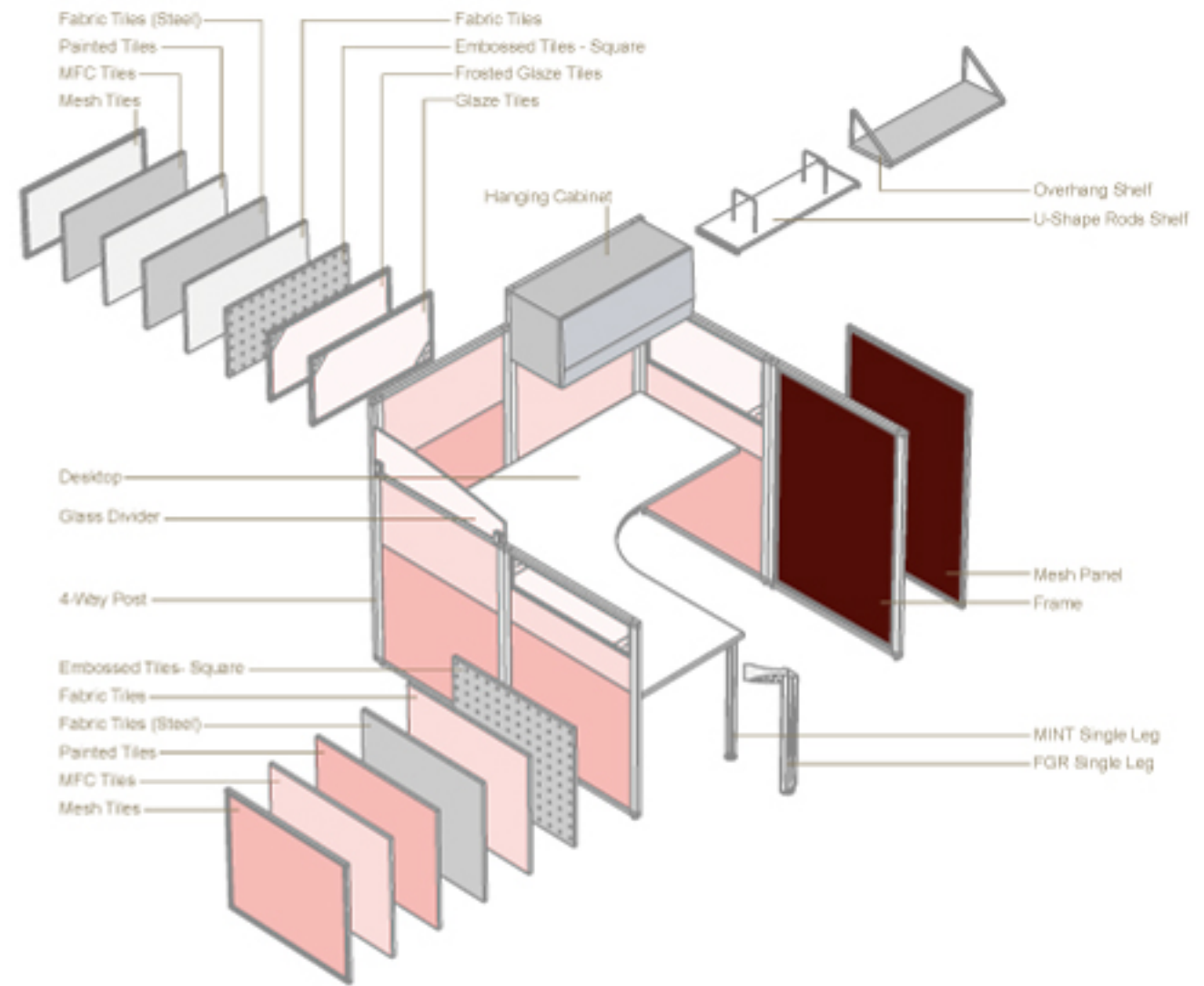

The Ecore series configures easily through linking brackets positioned on the end of the screens. Many configurations are possible, and with hanging storage units and accessories that attach directly onto Ecore screens an entire workstation fitout can be completed in the Ecore series.



## Ecore

Ecore can create unique and office tailored system's solutions such as the cubicles with counters shown below. As a result, efficiency in the workplace can be enhanced and morale can be increased as barriers to effective workflow are broken down.

## Ecore

Scope can be made into a height of 2100mm managerial working area, arranged with door panels giving more privacy to personal space.

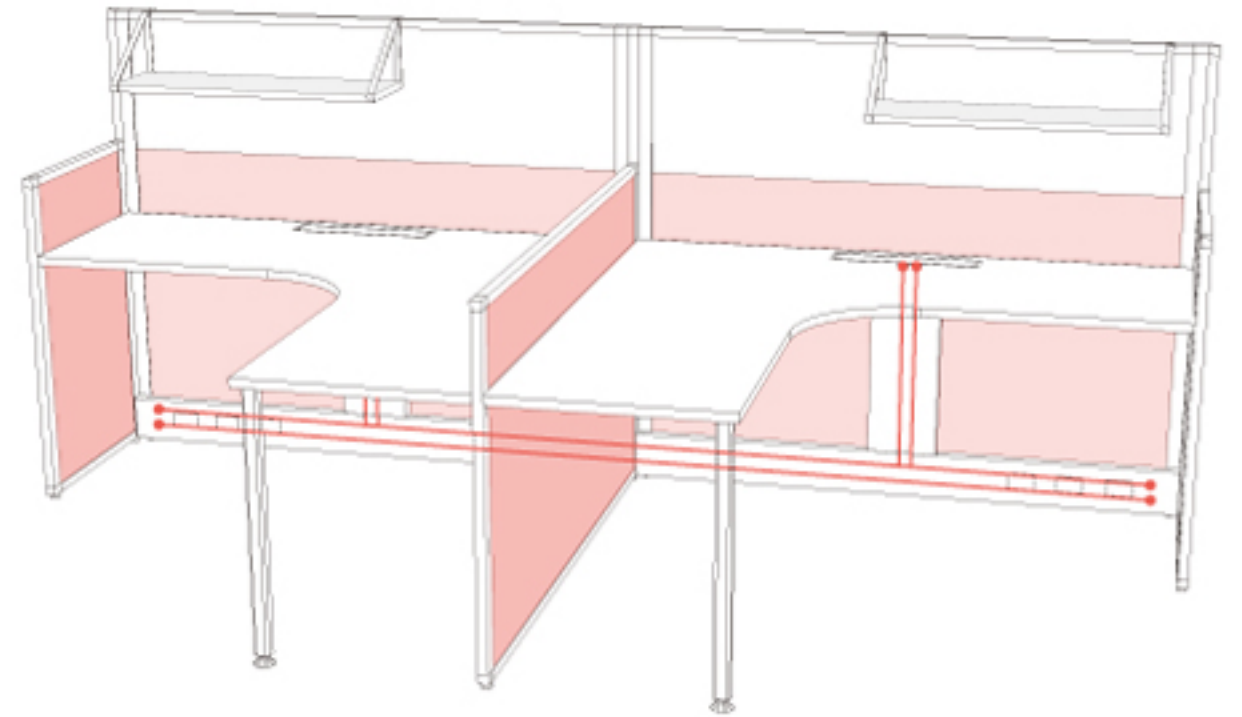

Power and data can be run through conduits at either the feet of the Ecore series or above the desk, which adds a high level of practicality to the system.





## Projects

Ecore configures easily for use in any office interior. It is extremely versatile, offers a high level of customisability and is exceptional value. For this reason it is a great choice for corporate fitouts.





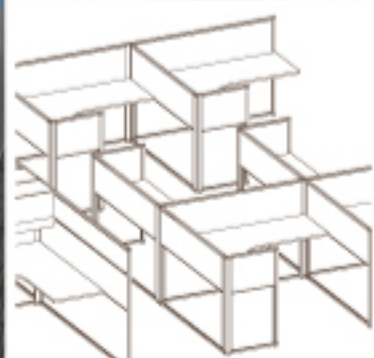
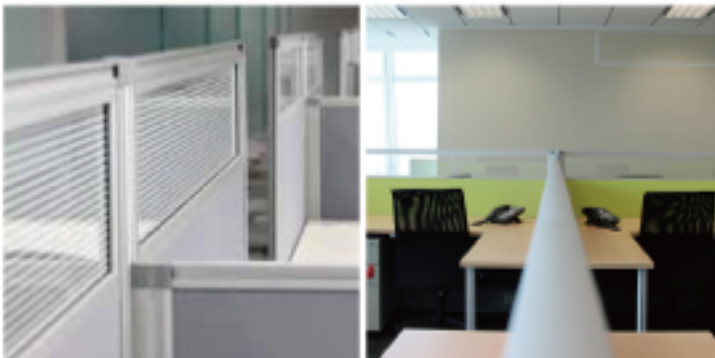
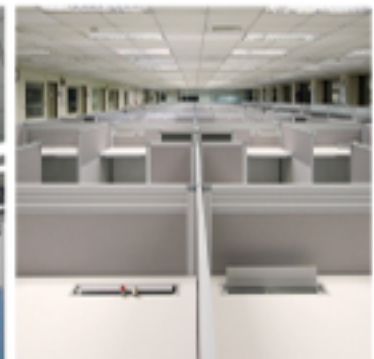



A modern office workstation featuring a light wood desk with a silver metal frame and a perforated metal privacy screen. The desk is equipped with a laptop, a white coffee cup, a small white speaker, a vase of red flowers, and a bowl of fruit. A white shelf with three brown binders is attached to the left side. The workstation is situated in an office environment with other cubicles visible in the background.

IVIK

## *IVIK Series*

IVIK is a benching system for multiple levels of mobility and fast communication between peers.



## IVIK Series

IVIK can be an effective solution for modern office. It brings a great advantage of social network when a work team shares information to each other quickly and smoothly.

IVIK



Energy



IVIK

Benching systems are Eco-friendly which with fewer materials required and more Green than other options.



Energy

## Series

IVIK, an open plan system, is with rows of desks filled with workers who collaborated on their daily task to create an efficient business model.



By combining the furniture types, large open areas can be separated by group or department. It offers the flexibility to easily change an area from private to semi-private or non-private workstation.



IVIK



### IVIK Series

A brilliant combination of IVIK & AXIS 808 to be present; Axis series has been developed for over 20 years, IVIK links Axis 808 for not just offering privacy screens, but also flexible design to match user's requirement.

## IVIK

IVIK is based on the effective way to connect the unique supporting structure continuous with several accessories and meet various job needs.

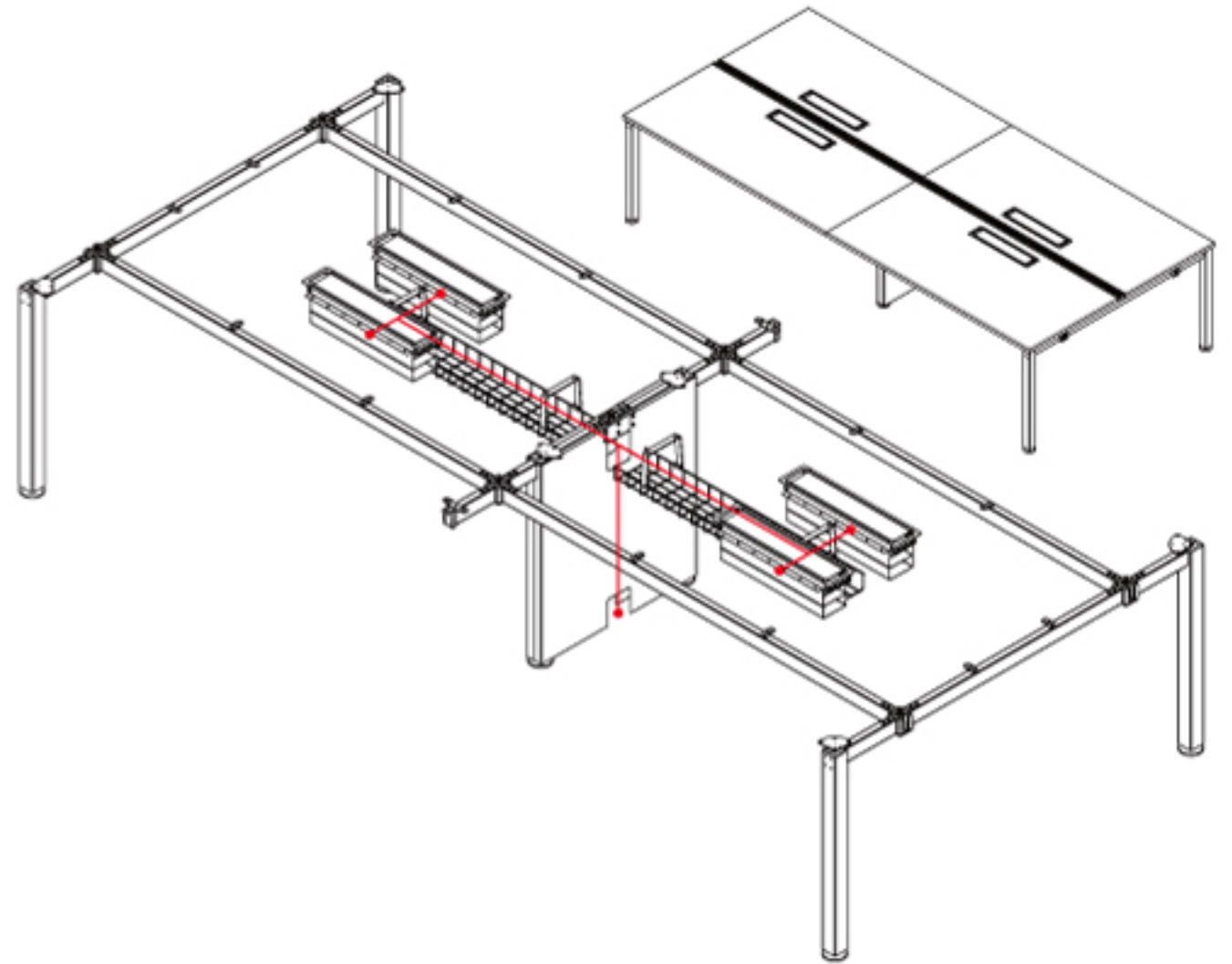

The lower walls and open spaces also contribute to better usage of natural lighting and better circulation. IVIK enabled a line-of-sight connection between workers yielded more improvement in workplace productivity.